

General information on fitting water pumps and flushing the cooling circuit.



During changing of the water pump and the associated flushing of the cooling circuit, errors are often made, which can result in contamination of the new coolant and can jeopardize the proper performance of the new water pump. It is therefore especially important to flush the **entire** cooling circuit **before** changing the water pump, adhere to the specifications relating to sealing the water pump and use the correct coolant.

! Please note the following general tips on replacing the water pump and flushing/refilling the cooling circuit:



- Drain used coolant in accordance with manufacturer's instructions (loosen drain plug, lower radiator hose etc.).
- Collect coolant and dispose of in accordance with applicable regulations (**Caution: Toxic, contains glycol**). Old coolant must not be reused.



- If old coolant is heavily contaminated, it is essential to check and, if necessary, replace thermostat.



→ Mix clear water with cleaning additive (e.g. MB A0009891025, Liqui Moly 3320, etc.) in correct ratio and pour into cooling system.

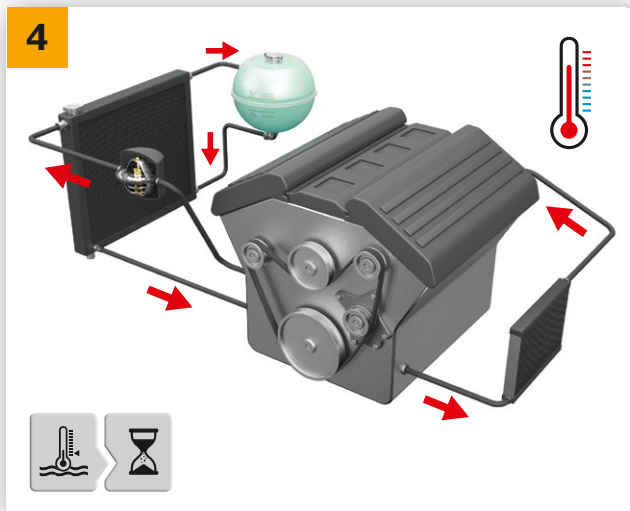

→ Bring engine to operating temperature so that coolant thermostat opens large cooling circuit. Switch heater to highest setting, leave to act for period specified in manufacturer's specification for product.



→ Drain cleaning mixture again as in step 1
(Caution: Risk of scalding).
 → Repeat steps 3 and 4 if necessary, depending on degree of contamination of drained mixture.

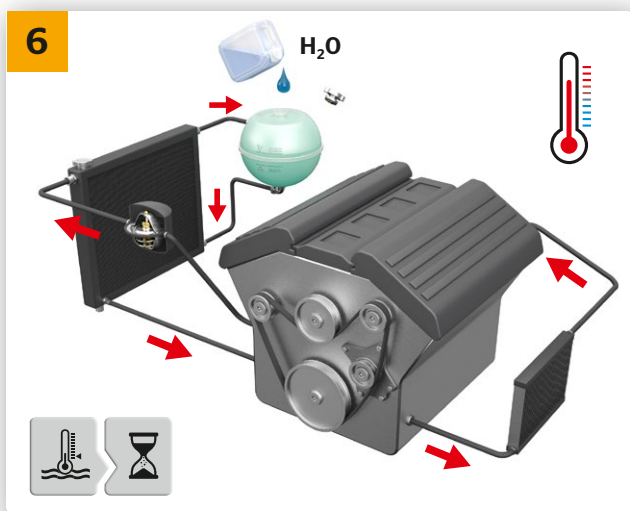

→ Fill coolant circuit with clear water. Bring engine to operating temperature at 2500 rpm and drain water again as described in steps 1 and 5.



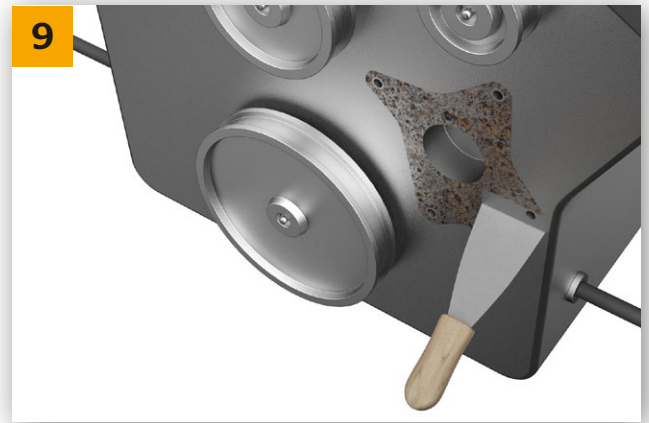
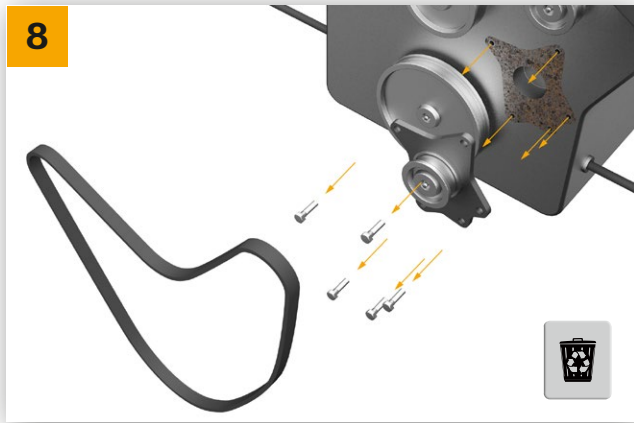

→ Now remove old water pump and thoroughly clean and degrease all seal surfaces.

Compare removed water pump with new part. IMPORTANT: Never turn water pump impeller when dry. This can damage mechanical shaft seal, causing a leak.



→ Fit new water pump in accordance with manufacturer's specification. It is essential to adhere to specified tightening torques and information on use of seals/sealants.

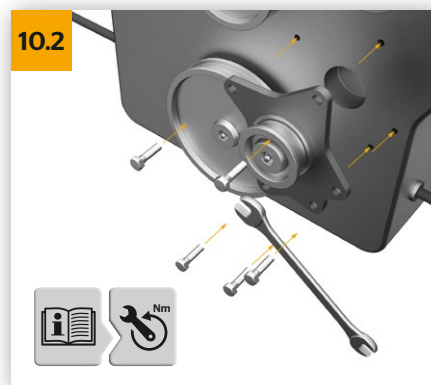

→ Only use sealing compound if this is explicitly specified for this water pump. In water pumps fitted using such a liquid sealant, ensure that sealant is applied sparingly and uniformly and that curing times are observed before refilling cooling circuit. Coolant can otherwise be contaminated. Tighten fastening bolts of water pump alternately to specified torque.



→ If water pump is prefitted with seal or O-ring, no sealant may be used. Wet prefitted O-rings with coolant before fitting pump. Do not use grease.



→ Fill cooling system with new coolant in correct mixing ratio of anti-freeze to water. Only use anti-freeze concentrates approved for vehicle. Different limit values (hardness, pH) apply to water used, depending on vehicle manufacturer and year of manufacture. If in doubt, use distilled water.



→ Bleed cooling circuit in accordance with manufacturer's specification (use filling device, if necessary) and check for leaks. Brief, slight escape of water at water pump drain opening is possible and will stop after short time.

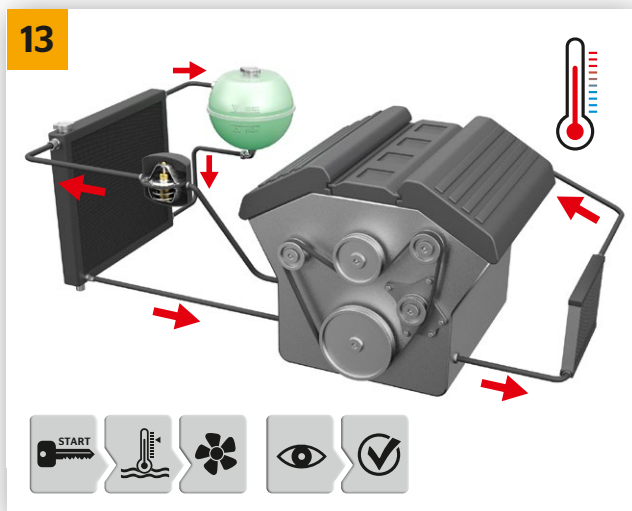

→ Carry out test drive or run until operating temperature has been reached. Then check again for leaks and system level (**Caution: Risk of scalding**).

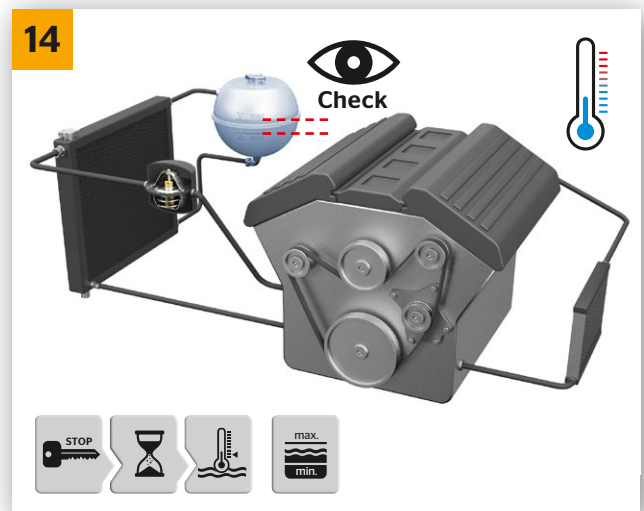

The content of this publication is not legally binding and is provided as information only. The trademarks displayed in this publication are the property of Continental AG and/or its affiliates. Copyright © 2017 ContiTech AG. All rights reserved. For complete information go to: www.contitech.de/discl_en

